



J A R S

— C A T A L O G U E —

www.sunrisegipl.com



”

WHAT IS

SUNRISE GLASS

Sunrise Glass Industries Pvt. Ltd., a division of Astron Group, is a leading glass manufacturer based in Surat, Gujarat. We are India's fourth-largest container glass manufacturer, operating at a capacity of 650 MT per day. Our products include Flint wine bottles, food jars, sauce bottles, milk bottles, and water bottles. We have been recognized as the TRIAL FONT Most Trusted Container Glass Manufacturer TRIAL FONT by Worldwide Achievers. Our clients include Pernod Ricard and Diageo, and we export to the USA, Poland, Europe, Spain, Italy, Canada, Vietnam, Myanmar, Indonesia, Sri Lanka and to all major African nations. We are also suppliers to brands like Sula and Fratelli. In the food segment, we supply jars and bottles to companies like Amul, Mahananda, and Nestle. We are committed to delivering high-quality products and excellent customer service.

A white line-art illustration of a glass bottle, showing its neck, body, and base, positioned to the left of the main title.

OUR CAPACITY

Our factories, situated in Surat, Gujarat, hold a total of three furnaces and have a capacity of 650 MT per day at present. The varied production line is divided into 14 lines, each with variations of SGT DG and TG machines consisting of 6 to 8 section

SUNRISE GLASS IND. PVT. LTD. retains a total of three furnaces with a combined capacity of 650 MT per day, which positions us as the fourth largest glass container manufacturer in India. Additionally, we are proud to be recognized as the fastest growing glass manufacturer in the country.

WHY GLASS IS GOOD?

-  Inert
-  Non Leaching
-  Connoting Premium Quality
-  Impermeable
-  Infinitely Recyclable
-  Hermetic sealing
-  Odourless
-  Microwave Safe
-  Prolonged Shelf Life



FDA Approved

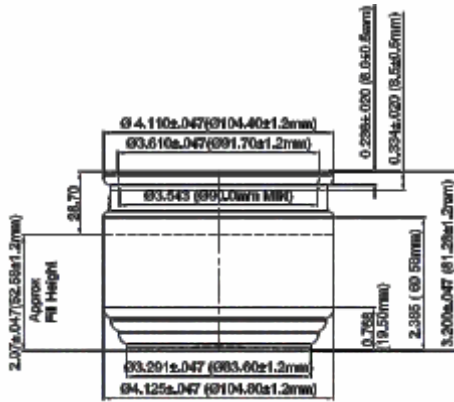

11.05 OZ CANDLE JAR

BRIMFULL

17.99 FL OZ ± 55 FL OZ (532±16 ML)

(OVERFLOW CAP)

11.50 FL OZ ± 55 FL OZ (FILLING CAP)

WEIGHT

9.70 OZ ± 45 OZ

275 ± 13.5 GMS

FINISH

SPECIAL CHECK

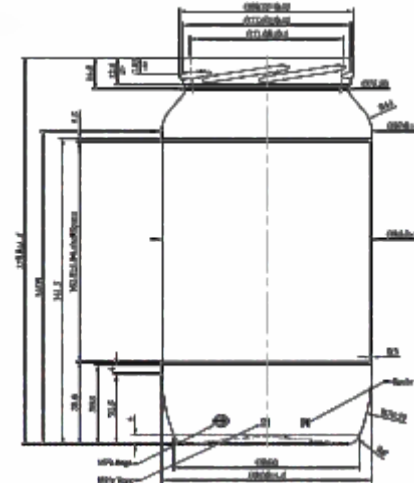

1 KG GENERAL JAR

BRIMFULL
1021 ± 4 ML

WEIGHT
480 ± 20 GMS

FINISH
82 MMLUG CAP
(FD-130)

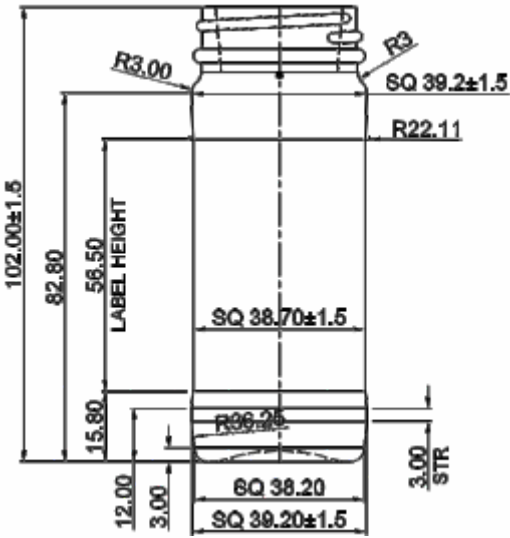

95 GMS. NEW IPL SQUARE

BRIMFULL	WEIGHT	FINISH
95 ± 3 ML	95 ± 6 GMS	37.5 M SPL (H-9.35)

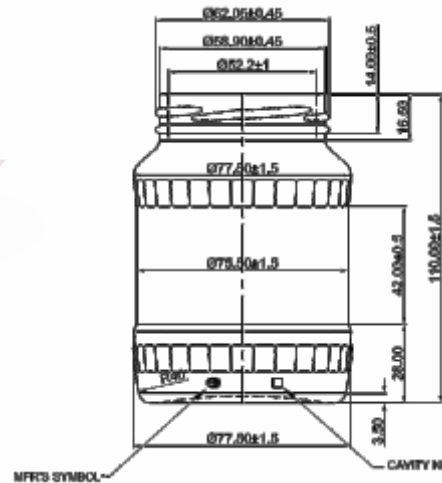

370 ML FLUTED JAR

BRIMFULL	WEIGHT	FINISH
370 ± 6ml	205 ± 15 GMS	63 MM LUG Finish

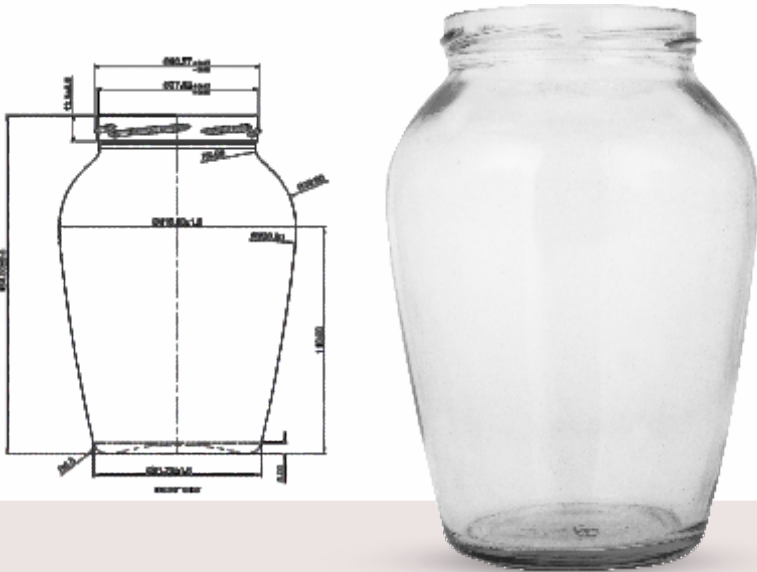

1 KG GHEE BOTTLE

BRIMFULL	WEIGHT	FINISH
1059 ± 14 ML	480 ± 20 GMS	82MM LUG CAP

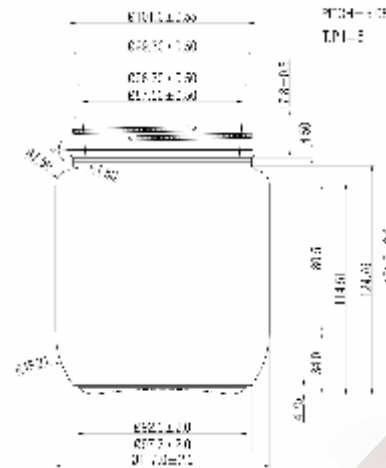

1 KG. JAR ROUND

BRIMFULL	WEIGHT	FINISH
1240 ± 15 ML	550 ± 20 GMS	AS PER DRG.

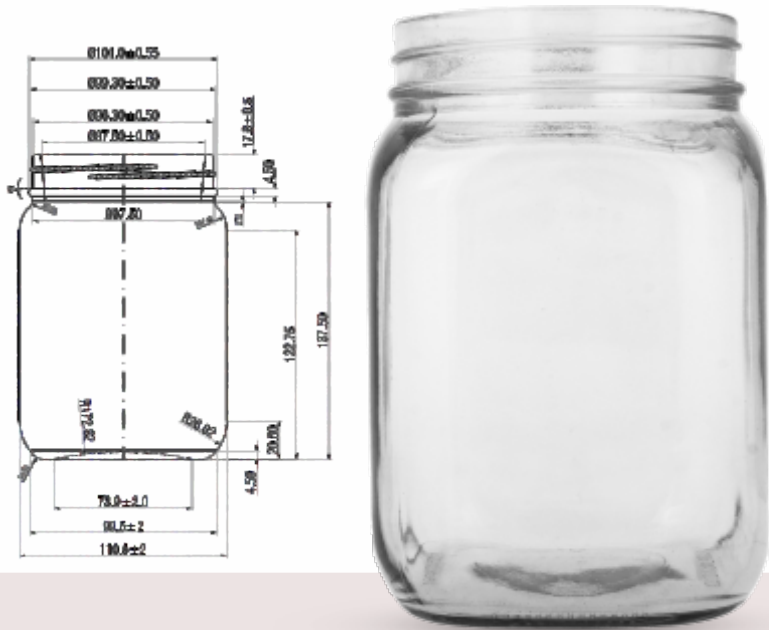

1 KG. SQUARE JAR JS-3

BRIMFULL	WEIGHT	FINISH
1410 ± 20 ML	550 ± 20 GMS	AS PER DRG

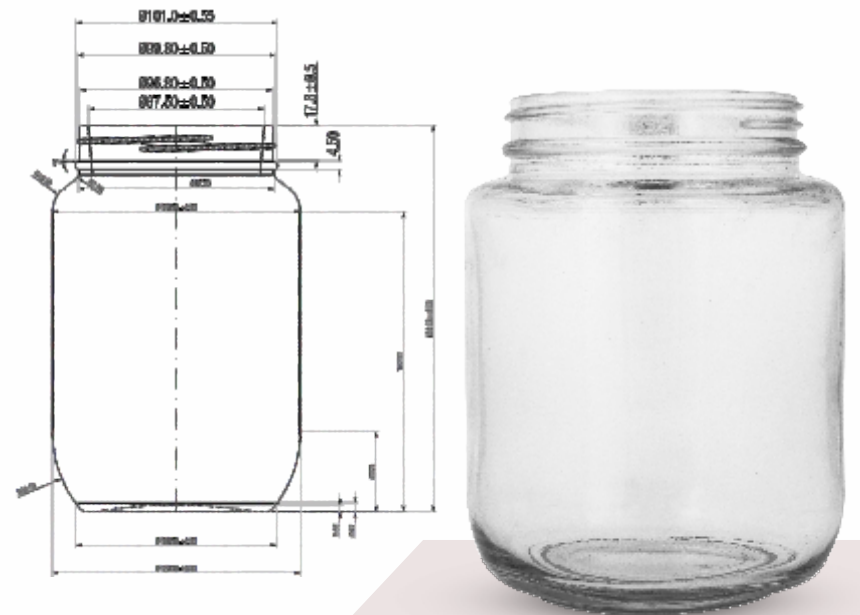

1.5 KG ROUND JAR

BRIMFULL	WEIGHT	FINISH
1818 ± 18 ML	650 ± 20 GMS	AS PER DRG

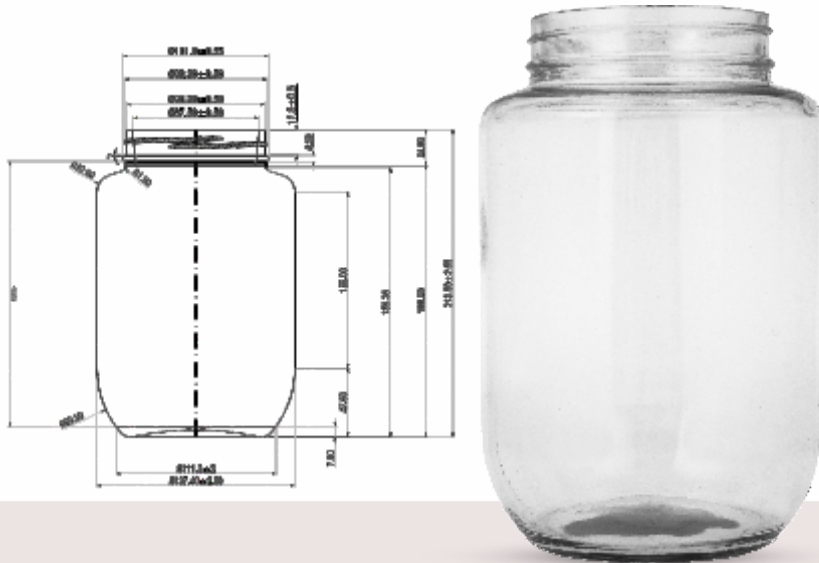

2 KG ROUND JAR

BRIMFULL	WEIGHT	FINISH
2460 ± 25 ML	785 ± 25 GMS	AS PER DRG

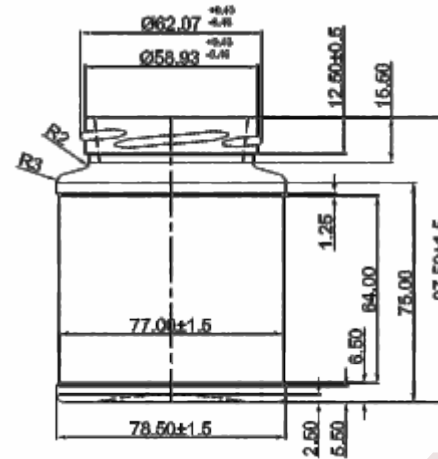

250 GMS HEXAGONAL JAR

BRIMFULL	WEIGHT	FINISH
270 ± 7 ML	205 ± 15 GMS	63 MM LUG CAP

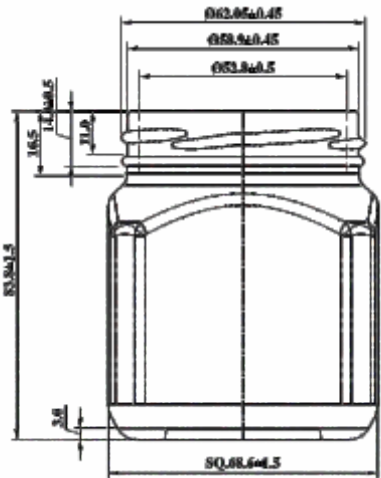

250 ML SQUARE JAR

BRIMFULL	WEIGHT	FINISH
260 ± 6 ML	175 ± 12 GMS	63 LUG WITH BEAD

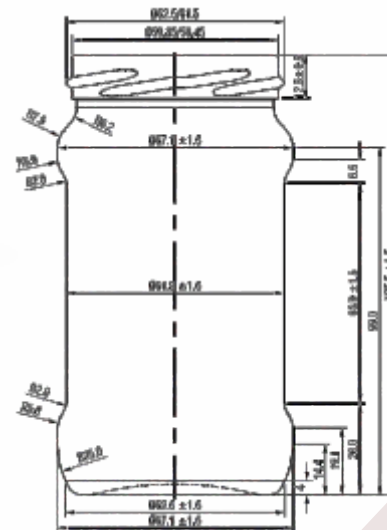

300 GMS FUDKOR JAR

BRIMFULL	WEIGHT	FINISH
300 ± 15 ML	205 ± 16 GMS	63 LUG WITH BEAD

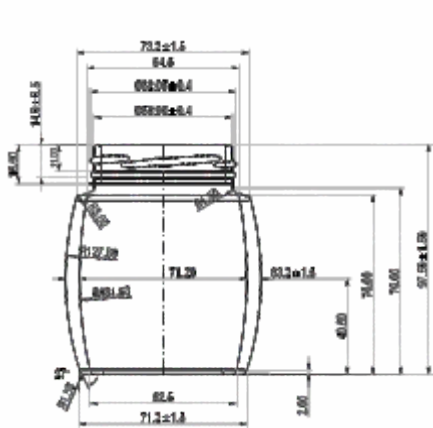

300 ML FRUITY JAR

BRIMFULL	WEIGHT	FINISH
350 ± 15 ML	240 ± 15 GMS	63 MM LUG CAP WITH BEAD

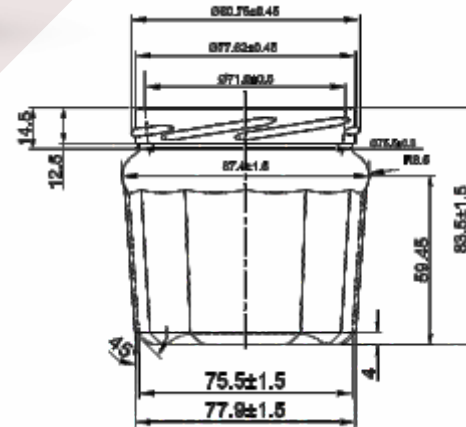

300 ML POLYGON JAR

BRIMFULL	WEIGHT	FINISH
314 ± 6 ML	230 ± 10 GMS	82 MM LUG CAP WITHOUT BEAD

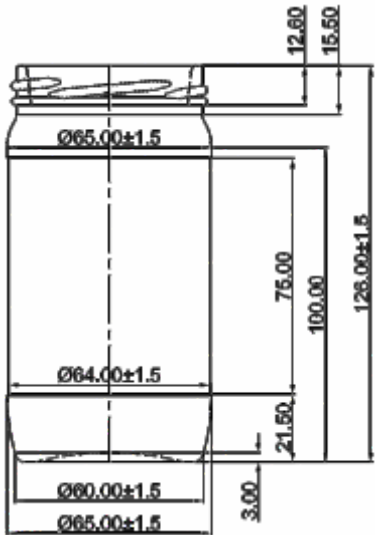

300 ML ROUND JAR 777

BRIMFULL	WEIGHT	FINISH
308 ± 5 ML	200 ± 10 GMS	63 LUG WITH BEAD

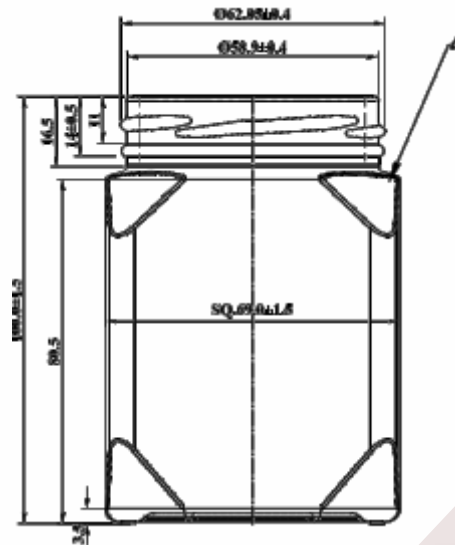

330 ML SQUARE JAR

BRIMFULL	WEIGHT	FINISH
330 ± 6 ML	205 ± 15 GMS	63 LUG WITH BEAD

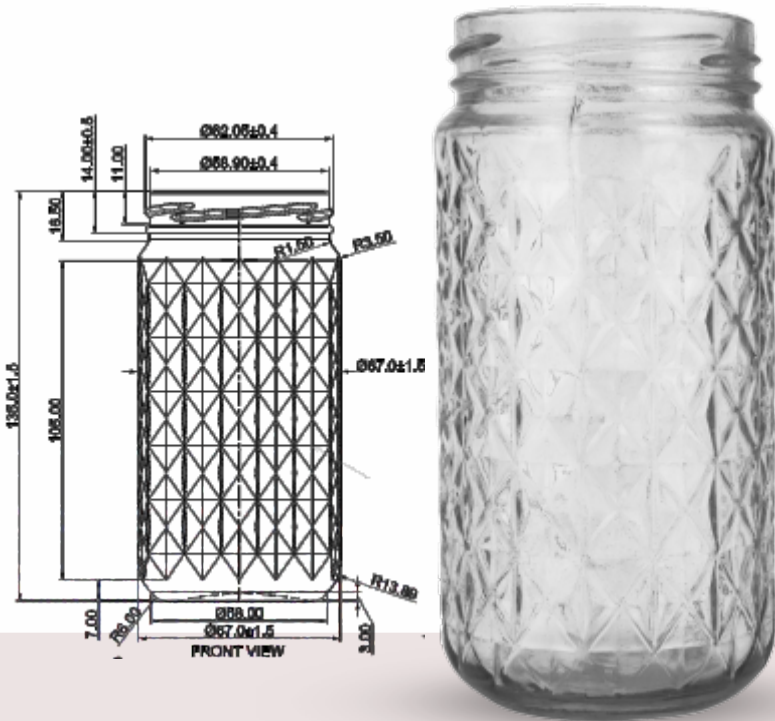

370 ML DIAMOND JAR

BRIMFULL	WEIGHT	FINISH
370 ± 6 ML	370 ± 6 ML	63 LUG WITH BEAD

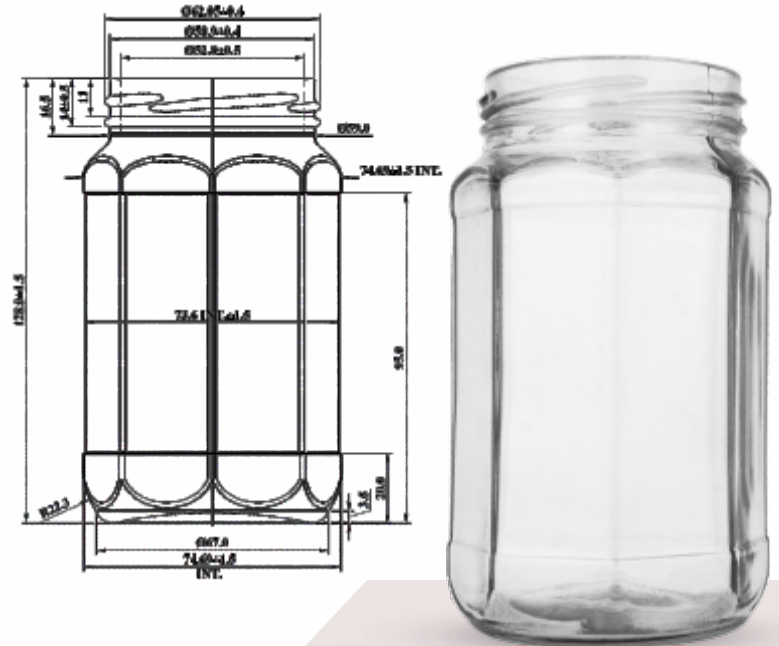

370 ML OCTAGONAL JAR

BRIMFULL	WEIGHT	FINISH
370 ± 6 ML	230 ± 15 GMS	63 MM LUG WITH BEAD

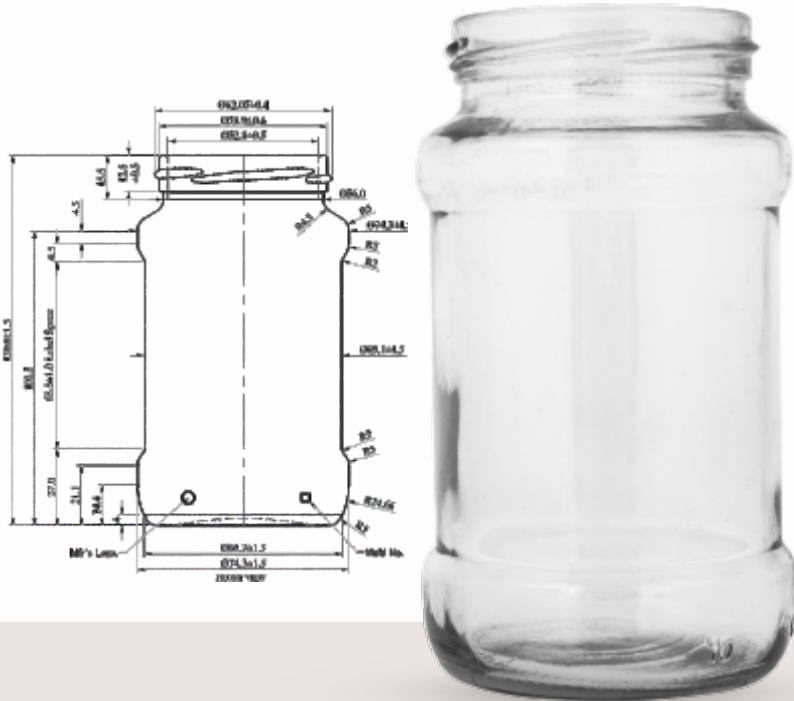

400 GMS FUDKOR PLAIN JAR

BRIMFULL	WEIGHT	FINISH
380 ± 6 ML	230 ± 15 GMS	64 MM LUG CAP (GPI-2020)

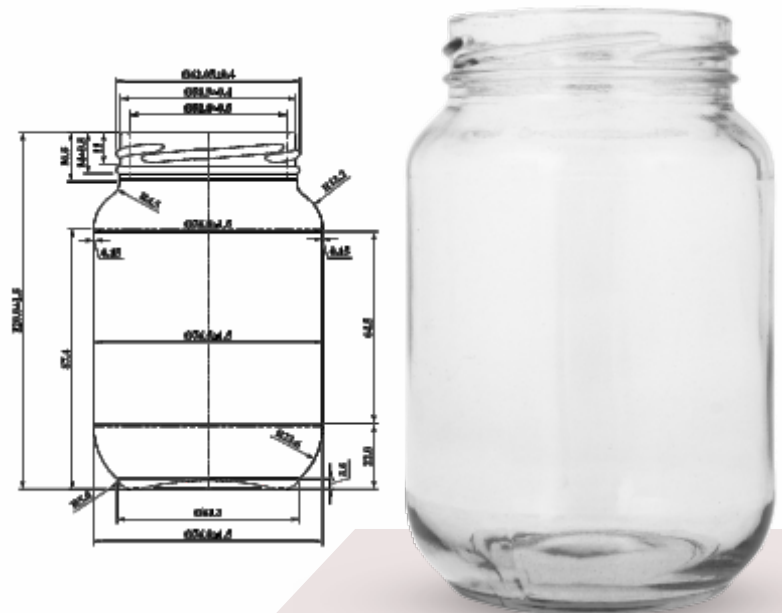

400 ML ROUND JAR

BRIMFULL	WEIGHT	FINISH
408 ± 6 ML	205 ± 15 GMS	63 LUG WITH BEAD

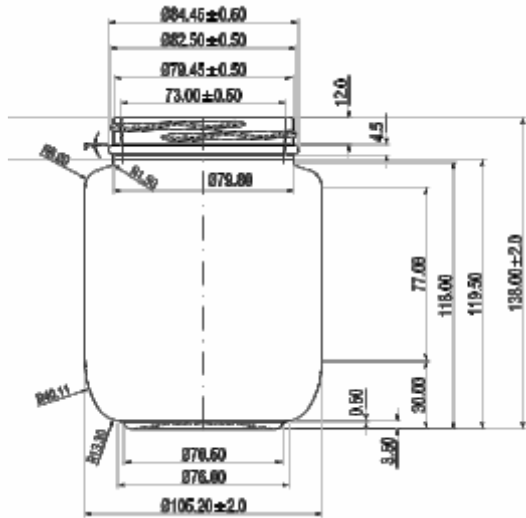

750 GMS JAR ROUND

BRIMFULL	WEIGHT	FINISH
865 ± 15 ML	480 ± 20 GMS	83 MM-GPI -4010

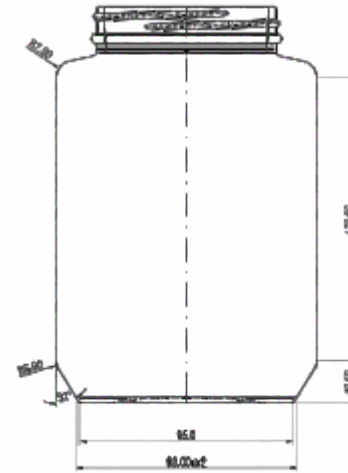

1000 ML CUBICAL JAR

BRIMFULL	WEIGHT	FINISH
1090 ± 20 ML	550 ± 20 GMS	83 MM S/N SPECIAL AS PER DRG

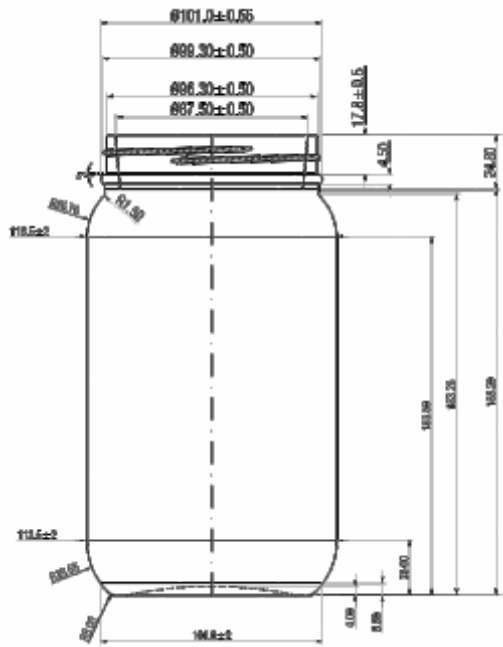

1800 ML. SQUARE JAR

BRIMFULL	WEIGHT	FINISH
1895 ± 25 ML	785 ± 25 GMS	101 MM S/N (AS PER DRG)



Sunrise To Top Customers In Every Segment



Liquor



DIAGEO



Pernod Ricard



Food
Beverages



Sof Drink



Other



Pharmaceutical





 +91 9879609021 , +91 90999 03157

 sales@sunrisegipl.com, exim@sunrisegipl.com

 Sunrise Glass Industries Private Limited
Block No. 41 & 46, (Near Rama paper mill colony)
Bardodhan Tena Road Village : Tena, Taluka : Oldpad,
Dist. : Surat (Gujarat).

www.sunrisegipl.com